

BULTEH 2000 Ltd.

Industrial Area, VERA PLAST building, Stara Zagora **BULGARIA**
Tel./Fax:(+359 42) 260 19; Tel. :(+359 42) 620896 e-mail bulteh@sz.inetg.bg

EKOMILK

MILK ANALYZER MILKANA KAM98-2A

Ultra PRO

Ultrasonic Milk Analyzers

FAT, SNF, DENSITY, ADDED WATER, FREEZING POINT, PROTEIN

ADDITIONAL OPTIONS:

- CONDUCTIVITY**
- pH, TEMPERATURE**
- COLLECTING AND PRINTING DATA**

OPERATING INSTRUCTIONS

TABLE OF CONTENTS

TABLE OF CONTENTS	2
EKOMILK-ULTRA ULTRASONIC MILK ANALYZERS - KEY FEATURE....	3
CONTROLS (ON THE FRONT AND REAR PANELS)	4
PARTS AND ACCESSORIES.....	5
MAINS	6
MILK SAMPLES.....	7
BASIC MODES FOR USE	7
COLLECTING AND PRINTING DATA (IN CASE OF MICRO PRINTER CONNECTED TO THE ANALYZER).....	7
DATA TRANSFERRING	8
MILK ANALYSIS	10
CLEANING OUT	12
CALIBRATION.....	13
CALIBRATION VALUES SAVING	14
CONDUCTIVITY CALIBRATION.....	15
PH CALIBRATION	16
TIME & DATA CALIBRATION.....	18
PH MEASUREMENT - ADDITIONAL INFORMATION.....	18
MILK CONDUCTIVITY - ADDITIONAL INFORMATION:.....	23
ERROR'S LIST.....	23
GUARANTEE	26



EKOMILK-ULTRA ULTRASONIC MILK ANALYZERS - KEY FEATURE

EKOMILK-ULTRA Ultrasonic Milk Analyzers are designed for fast and cost effective analysis of the fat contents, non fat milk solids (SNF), protein, milk density for both cow and sheep milk and added water to milk as well.

Key feature:

- Fast Analysis - Allows a large number of measurements to be done;
- Simple and lightweight design;
- Cost effective:
- Low power consumption;
 - Very small quantity of milk required;
 - No acid or other chemicals are used;
- One year full warranty;
- Measuring accuracy adjustment can be done by the user;

RS 232 Interface (optional on request);

Environmental Conditions:

Ambient air temperature	15° - 30°C
Milk temperature	15° - 30°C
Relative humidity	30% - 80%

Electrical Parameters:

AC Power Supply voltage	220V ±5%
DC Power Supply voltage	12V to 14,2V
Power Consumption	30W max

Mechanical Parameters:

Dimensions (WxDxH)	95 x 300 x 250 mm
Weight	3.5 kg

Measuring Parameters:

Fatness	from 0,5% to 9% with accuracy ± 0,1%
Solids non fat (SNF)	from 6% to 12% with accuracy ± 0,2%
Milk density	from 1,0260 g/cm ³ to 1,0330 g/cm ³ ± 0,0005 g/cm ³
Protein	from 2% to 6% with accuracy ± 0,2%
Added water to milk	from 0% to 60% with accuracy ± 5%
pH*	from 0,00 to 14 pH with accuracy ± 0,02
Conductivity*	from 2 to 20 mS/cm ± 0,5 % mS/cm (18°C)
Temperature*	from 0 to 50 °C with accuracy ± 0,1°C
Measuring cycle	30 sec

*** These options are additional. If someone is not installed, the inscription NA (Not available) will appear on the display instead of result.**

CONTROLS (ON THE FRONT AND REAR PANELS)

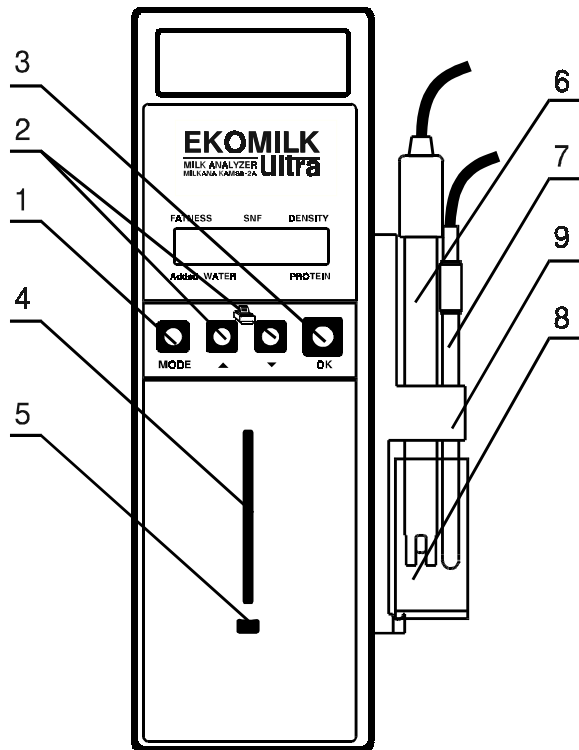
CONTROLS
(on the front panel)

1. Select the work mode
2. Skip and search forward and backwards
3. Confirm the choice
4. Tube (sucker)
5. Plastic support
6. pH Electrode
7. Thermometer Probe
8. Measuring mug for pH, Temperature
9. Holder for pH Electrode and Thermometer Probe

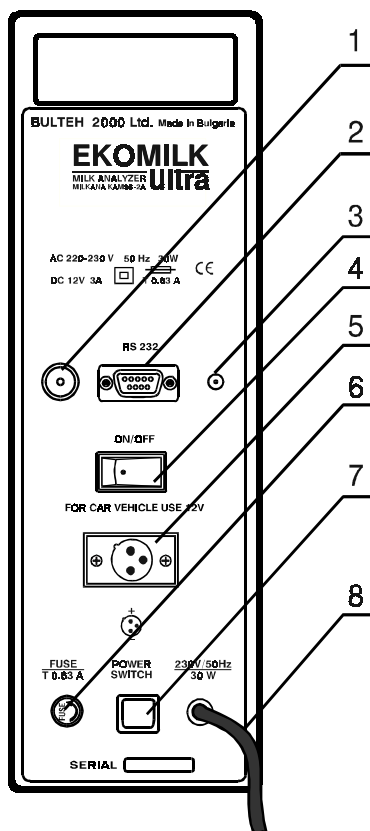
SWITCHES and OUTLETS
(on the rear panel)

1. pH socket (BNC)
2. RS 232 Interface outlet
3. Temperature outlet
4. ON/OFF Switch - for car vehicle
5. 12 V DC outlet
6. FUSE
7. POWER Switch - 220V/50Hz
8. 220 V AC power led

PARTS AND ACCESSORIES

Item	Description	Qty
1.	EKOMILK-M	1
2.	Holder for pH electrode and temperature probe	1
3.	Temperature probe	1
4.	pH electrode	1
5.	User's guide	1
6.	Connector 12V	1
7.	CD Milkanalyzer software tools	1
8.	RS232 Cable (Null Modem, Link cable)	1
9.	Measuring mug	4
10.	Buffer solution Conductivity 500 ml 5.02 ($\pm 0,5\%$) mS/cm ($18\pm 0,1^{\circ}\text{C}$).	1
11.	Buffer solution 60 ml pH $7.00 \pm 0,01/20^{\circ}\text{C}^*$	1
12.	Buffer solution 60 ml pH $4.00 \pm 0,01/20^{\circ}\text{C}^*$	1
13.	Buffer solution 60 ml pH $10.00 \pm 0,01/20^{\circ}\text{C}^*$	1
14.	Container with KCl 20 ml	1

pH buffer solution description (Pharmacopoeia standard)
(Use only this type buffer standard for calibrating)

Description	pH $7.00 \pm 0,01/20^{\circ}\text{C}$	pH $4.00 \pm 0,01/20^{\circ}\text{C}$	pH $10.00 \pm 0,01/20^{\circ}\text{C}$
Composition:	Potassium dihydrogen phosphate, Di - sodium hydrogen phosphate	Borax, Sodium hydroxide solution	Citric acid, Sodium hydroxide solution, Sodium chloride
Temperature characteristics:	10°C - 7.06 25°C - 6.99 20°C - 7.00 30°C - 6.98 40°C - 6.95 50°C - 6.91	10°C - 4.00 20°C - 4.00 25°C - 4.00 30°C - 4.00 40°C - 4.00 50°C - 4.05	10°C - 10.10 20°C - 10.00 25°C - 9.95 30°C - 9.90 40°C - 9.82 50°C - 9.75

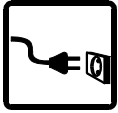

MAINS

Place the Analyzer vertically on a table or any other flat surface.

- AC Power Supply Voltage

Connect the AC power lead to the mains socket.

Set the Power switch to “On”.

- 12V DC Power Supply Voltage

Connect the DC supply lead to 12V outlet (black is “-”) and to the autonomous DC supply (for example car supply).

Set the +12 V Power switch to “On”.

1. Attach the holder onto Ekomilk

The Ekomilk comes complete with a Holder for pH electrode and temperature probe. It is designed for easy use and installation. Care must always be taken to avoid use of excessive force in the process of attaching this component. Ekomilk has two holes on the side for attachment of pH electrode and temperature probe via the Holder.

2. Connecting the pH electrode (pH socket - pos. 5 on the rear panel).

2.1. During this operation, it is important that water does not get onto the BNC electrode connector. Also avoid touching the connector with soiled hands. Connect the pH Electrode sliding the Electrode connector over the socket of the Ekomilk (BNC Connector). Ensure that the slot of the connector is in the line with the protrusions of the socket. Rotate the connector clockwise until it locks. Be careful not to use excessive force in this operation.

3. Connecting the temperature probe (Temperature outlet - pos. 3 on the rear panel).

The temperature probe uses a phono jack to connect with the socket on the Ekomilk.

4. Attaching the pH Electrode and Temperature probe onto the Holder.

Align the end of the electrode (sensor side) with the hole of the Holder. Insert the pH electrode into the hole of the Holder as shown. Repeat the same procedure with the temperature probe.

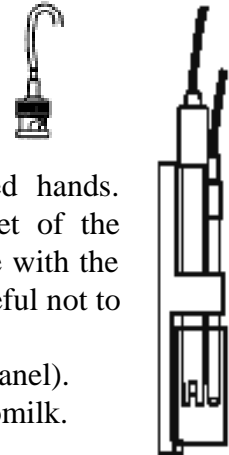

Warm up

When the power is on, **WARM UP** appears on the display. When the “warm up” stage is over in about 5 minutes, **EKOMILK** is shown on the display. The Analyzer is ready to use.

Do not take into consideration the first sample because it is likely to be with a deviation out of specification.

Warning: *The covers of the Analyzer should never be removed while the power leads are connected.*

Warning: *Under no circumstance should you try to repair the Analyzer’s power lead yourself. In case of power lead damage, contact your dealer to make the repairs.*



MILK SAMPLES

Milk samples temperature should be 15 - 30°C.

Milk with surface fat film should be heated to 40 - 45°C by means of water-bath. Stir up and cool it to 29 - 30°C. If the milk temperature is above 38°C the message **HOT SAMPLE** appears on the display. Milk acidity should be less than 25°T.

Use the milk sample only once. When the measuring is carried out, throw the sample away.

BASIC MODES FOR USE

Press the **MODE** button to enter basic modes menu. Basic modes available are as follows:

- COW MILK** - analysis of cow milk
- SEND & CLEAR** - data transferring mode;
- REC CHOICE** - turning on/off the data collection system;
- CLEANING** - cleaning in the end of working day
- CALIBRATION** - calibration
- SYSTEM** - manufacturer's mode only
- SHEEP MILK** - analysis of sheep milk

Press the search buttons **▲**, **▼** to select desired mode.



COLLECTING AND PRINTING DATA (IN CASE OF MICRO PRINTER CONNECTED TO THE ANALYZER)

1. SETTINGS

Press the **MODE** button only once. Press the search buttons **▲**, **▼** to select **REC CHOICE** mode. Press **OK** when **REC CHOICE** mode is displayed. The message **RECORD DATA?** appears on the display. Set with search buttons **▲**, **▼** the desired mode **Y** or **N**.

1.1. **N (NO)** - Milk analysis without printing data for vendor ID, Volume-liters. This is the standard work mode of Analyzer - pass to the next chapter "**MILK ANALYSIS...**".

After the current measurement is completed the results could be printed by pressing the arrow button **▲** on the analyzer front panel. Results are printed every time when this button is pressed.

Receipt will have this form:

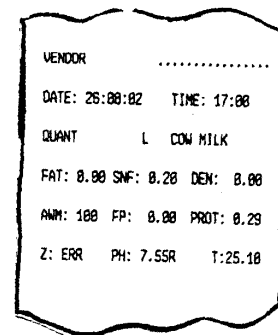

1.2. **Y (YES)** - Milk analysis with printing data for vendor ID, Volume-liters and milk parameters. When the power is on Milk analyzer enter into **Y (YES)** mode - milk analysis with printing data.

After the current measurement is completed the results could be printed by pressing the arrow button **▲** on the analyzer front panel. Results are printed every time when this button is pressed. Recipe will have this form:

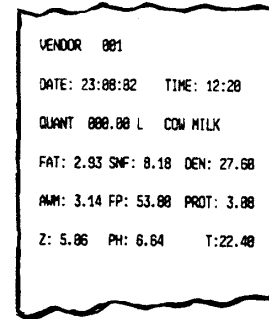

```

VENDOR 001
DATE: 23:08:02   TIME: 12:28
QUANT 000.00 L   COW MILK
FAT: 2.93 SNF: 8.18 DEN: 27.68
AMN: 3.14 FP: 53.00 PROT: 3.00
Z: 5.06 PH: 6.64   T: 22.40
  
```

2. COLLECTING DATA

The message **NUMBER: 001** appears on the display while measurement is started (it does not matter which measuring mode is activated - **COW MILK** or **SHEEP MILK**). **NUMBER** defines the ID number for everyone supplier. In this case it is necessary to write in advance s suppliers list by ID number and name.

- button **▼** changes the cursor position;
- button **▲** changes the over cursor value;
- button **MODE** cancels the changes and returns **COW MILK** on the display;
- button **OK** confirms the **ID NUMBER** and shows **QUANTITY:0000.0**;
- button **▼** changes the cursor position;
- button **▲** changes the over cursor value;
- button **MODE** cancels the changes and returns **COW MILK** on the display;
- button **OK** start measurement;

Before starting a new measurement, there is a possibility to erase the last measurement from the analyzer's memory. Press button **▼** and then press button **▲** not releasing button **▼**. The message **RECORD DISCARDED** appears on the display.

The maximum number of record can be 120. If you try to write more records, a **NO MEMORY SPACE** error message appears on the display. In this case you must transfer the data to a computer and clear (empty) the analyzer's memory (*See procedure described in "Data transferring"*).



DATA TRANSFERRING

Transfer requirements:

- Milk analyzer Ekomilk (Data Collection System installed);
- PC with Milk Data 2001 program Version 1.3;
- RS 232 Null Modem Cable;

Steps:

1. Connect the milk analyzer EKOMILK to the PC.

Switch off the milk analyzer and the PC. Connect the RS232 cable to some free COM port to the PC and to the RS 232 connector of Milk analyzer. First, switch the milk analyzer on, next switch on the PC.

2. Start Milk Data 2001 (version 1.3) program.

Choose **FROM MEMORY** from Setting menu. This mode allows you to transfer stored information in Analyzer's memory to the program Milk Data 2001.

3. Press a Milk Analyzer's **MODE** button only once. Press the search buttons **▲**, **▼** to select **SEND & CLEAR** mode. Press **OK**. While the data is transferring, the message **PLEASE, WAIT...** is on the Analyzer's display, followed by the message **TRANSFER OK?Y (or N)**.

On the bottom of the screen a progress bar provides users with visual feedback about the progress of a transmission procedure. As the procedure progresses, the rectangular progress bar gradually fills from left to right with the system highlight color.

ATTENTION!

WAIT ABOUT 1-2 MINUTES WHEN THE MESSAGE APPEARS ON THE COMPUTER SCREEN.

1. Transfer is successful

When transfer is completed successfully, new row are added to the table. The message **"The data received successfully! OK** appears on the computer's display.

If you want to erase the data and empty Analyzer's memory - set with search button **▲**, **▼** **TRANSFER OK?Y** and confirm with button **OK**. Message **READY** register that the erase process is completed. Now, you can make new 120 milk data records.

If you want keep data in the Analyzer memory - press button **MODE**. In this way the data remains in Analyzer's memory and it is possible to transfer it again to another computer.

2. No data received

This may be for one of following reasons:

1. Analyzer's memory is empty;

2. The RS232 cable is not correctly connected or it is damaged;

3. MILK DATA 2001 setup is not correct -

- choose **FROM MEMORY** option from Setting menu - the program version must be 1.3; choose the right COM port connected to the Milk analyzer.

In This case you must confirm TRANSFER OK?N or press button MODE.

Attention! TRANSFER OK?Y will erase all data.

3. Transmission error

In case of a transmission error a warning message will appear on the display:

The data received contains 1 error(s). Accept data? (YES or NO).

YES accepts only the correct data.

NO cancels all data.

In this case you can choose from Milkanalyzer **TRANSFER OK? N** and confirm with **OK**. This procedure transfers again the data. Wait for computer's message. If there is transmission error again, you can decide to accept the right data or to repeat once again the transfer.

If you want to erase the data and empty Analyzer's memory - set with search button **▲, ▼** **TRANSFER OK?Y** and confirm with button **OK**. Message **READY** register that the erase process is completed. Now, you can make new 120 milk data records.

If you want keep data in the Analyzer memory - press button **MODE**. In this way the data remains in Analyzer's memory and it is possible to transfer it again to another computer.



MILK ANALYSIS

Take out both plungers from the syringes. Insert the rubber plugs with the plastic tubes instead of plungers.

The Analyzer is ready for use in mode with suction pump.

Measurement

Steps: Fill the measuring mug with milk sample to be measured. Place the measuring mug on the plastic support (5) with the tube (sucker) into the milk sample.

pH and temperature measurement:

Remove the protective rubber cap of the pH electrode before proceeding with measurement. Take care not to exert too much force as this may cause damage to the electrode. Use de-ionized or distilled water to rinse the electrode before use. This will remove impurities that have adhered on the electrode body. Rinsing will also serve to activate the electrode, especially if it has been dehydrated (in which case you may have to soak the electrode in water from 10 minutes onwards (See Section "pH Measurement - Additional information"). Fill an other measuring mug with the same milk sample. Place it on pos. 8 and dip the electrode and temperature probe into the sample, ensuring that the electrode is completely immersed into the sample. Stir the mug gently to create a homogeneous sample.

Attention! The measurement of pH and temperature is separate from the measurement of fat, SNF, density, added water, protein and conductivity. If you don't place the mug with milk on pos. 8, you will have not right results for pH and temperature.

Press **MODE** and by means of the search buttons **▲, ▼** select the desired mode:

- **COW MILK** - analysis of cow milk
- **SHEEP MILK** - analysis of sheep milk

When the proper type of milk is displayed, press **OK** to start the measurement. Milk automatically is driven into the measuring camera.

The message **NUMBER: 001** appears on the display if Analyzer works in **COLLECTING AND PRINTING DATA** mode - for more information see part "**COLLECTING AND PRINTING**".

ATTENTION! The maximum number of records can be 120. If you try to write more records, **NO MEMORY SPACE** error message appears on the display. In this case you must transfer the data to a computer and clear (empty) the Analyzer's memory (See procedure described in section "Data transferring" - User's Guide).

The message **WORKING** appears on the display while measurement is going on.

*Warning: In case of formation of air bubble in the measuring camera the message **EMPTY CAMERA** will appear on the display. Then make a fresh start.*

When the measurement is completed the display shows the results for following milk parameters:

F: FAT %	T: TEMPERATURE °C
S: SOLIDS NON FAT (SNF) %	FP: FREEZING VALUE*
D: MILK DENSITY	Z: CONDUCTIVITY
P: PROTEIN %	PH: PH

**FREEZING VALUE = FREEZING POINT [°C] * (-100)*

Push button ▼ to see second display where there is **ADDED WATER TO MILK%** instead of **FREEZING VALUE**

F: FAT %	T: TEMPERATURE °C
S: SOLIDS NON FAT (SNF) %	W: ADDED WATER TO MILK%
D: MILK DENSITY	Z: CONDUCTIVITY
P: PROTEIN %	PH: PH

Push button ▼ once more if you want to see again first display.

**For more information, see "pH MEASUREMENT - ADDITIONAL INFORMATION" and "CONDUCTIVITY MEASUREMENT - ADDITIONAL INFORMATION".*

Attention: To get precise pH results, calibrate the pH measurement system at least twice weekly.

Attention:

- 1. If the probes (pH or temperature) is disconnected or the received results are out of spec limits or there is a damage in the measuring system, you will have message **ERR** instead of results.*
- 2. The pH result is valid when there is **R** (Ready) on the display, behind the value. If there is not it, you must make an other measurement to get a more precise result.*
- 3. pH result is strongly dependent on the temperature. If the pH electrode is connected, but the temperature probe is not, the pH result will be reduced to value at 25°C. It is possible the received pH result to be without spec accuracy $\pm 0,02$. In this case is no importance if **R** is displayed behind the pH result.*

Before starting a new measurement, there is a possibility to erase the last measurement from the analyzer's memory. Press button ▼ and then press button ▲ not releasing button ▼. The message **RECORD DISCARDED** appears on the display.

In case of measuring system damage, the message ERROR 10 will appear on the display. Contact your dealer to make the repairs.

In case of insufficient milk in measuring camera (or measuring system damage) ERROR 11 will appear on the display. Pour some more milk and make fresh start.



CLEANING OUT

Daily procedure

It is necessary to clean the analyzer in the following cases:

1. The interval between two consecutive measurements is more than half an hour;
2. End of working day.

Notes: Make sure the Analyzer is always cleaned properly, otherwise the device sensor will be contaminated and damaged soon.

Cleaning out WITH MOTOR (SUCTION PUMP)

Fill the measuring mug with warm, but not hot, and clean water (40°- 60°C). Press the **MODE** button once. Press the search buttons ▲, ▼ to select **CLEANING**. Confirm with **OK**. The display shows message **CYCLES 01** - number of cleaning cycles to be done. One cleaning cycle pumps the water in and back five times. Press the search buttons ▲, ▼ to set the desired number of cleaning cycles. This number can range from 1 to 99. We recommend one or two cleaning cycles to be chosen in case a regular cleaning procedure is performed. When the desired number is displayed, press **OK** to start the cleaning. When the **CLEANING** stage is over **CLEANING END** is shown on the display. Remove the mug and throw away the muddy water. Repeat this procedure several times till clean water comes out from the Analyzer.

Weekly procedure

Weekly procedure

To ensure a good work of the EkomilkPro Analyzer it is advisory to clean the Analyzer once a week minimum.

Take out both rubber plugs with the plastic tube from the syringes. Insert both plungers instead of the rubber plugs with the plastic tubes.

Fill the two measure mugs with warm, but not hot, and clean water (40°- 60°C). Place the measuring mug on the plastic support (5) with the tube (sucker) into the water. Pull up and push down both plungers one by one several times.

Push down as far as possible both plungers and remove the mug and throw away the muddy water. Repeat above procedure several times till clean water comes out from the Analyzer.

pH Electrode Cleaning and Storage procedure (See section “pH MEASUREMENT - ADDITIONAL INFORMATION”)



CALIBRATION

The Analyzer should be calibrated if the measuring accuracy for one or more milk parameters is out of the specified limits.

Calibration values determination:

- Determine a milk sample FAT contents by means of a classical method (for example you can use Gerber method);

- Test the same milk using Milkanalyzer;

- Subtract the Milkanalyzer **FAT** value from **FAT** value achieved with classical method. If the difference value is in the spec limits there is no need of fat calibration. Otherwise add this difference value as a fat calibration value using the procedure described in “*Calibration values Saving*”;

- Determine a milk sample SOLIDS NON FAT (SNF) by means of a classical method;

- Test the same milk using Milkanalyzer;

- Subtract the Milkanalyzer **SOLIDS NON FAT (SNF)** value from **SOLIDS NON FAT (SNF)** value achieved with classical method. If the difference value is in the spec limits there is no need of **SOLIDS NON FAT (SNF)** calibration. Otherwise add this difference value as a **SOLIDS NON FAT (SNF)** calibration value using the procedure described in “*Calibration values saving*”;

- Determine the milk sample DENSITY by means of a density meter;

- Test the same milk using Milkanalyzer again;

- Subtract the Milkanalyzer **DENSITY** value from **DENSITY** value achieved with classical method. If the difference value is in the spec limits there is no need of milk **DENSITY** calibration. Otherwise add this difference value as a milk **DENSITY** calibration value using the procedure described in “*Calibration values Saving*”;

Note: If you will calibrate both SOLIDS NON FAT (SNF) and DENSITY parameters, first calibrate SOLIDS NON FAT (SNF). Test the same milk using EKOMILK Analyzer again. Calibrate the DENSITY only if it is necessary.

- Determine a milk sample PROTEIN contents by means of a classical method (for example you can use Kjeldahl method);

- Test the same milk using EKOMILK Analyzer;

- Subtract the Milkanalyzer **PROTEIN** value from **PROTEIN** value achieved with classical method. If the difference value is in the spec limits there is no need of protein calibration. Otherwise add this difference value as a protein calibration value using the procedure described in “*Calibration values Saving*”;



CALIBRATION VALUES SAVING

- To save a new calibration value press **MODE** button first.
- Press the search buttons \blacktriangle , \blacktriangledown to select calibration mode:
 - CALIBRATION**
- Press **OK**.
- The display shows **PASS 1** - first password number prompt.
- Set with search buttons \blacktriangle , \blacktriangledown the first password number. Press **OK** to confirm it.
- A prompt for the second password number appears on the display - **PASS 2**. Enter the second password number then in the same way as the first one. Enter the third password number when a **PASS 3** prompt appears on the display.

*Note: In case of incorrect password is entered, a message **WRONG PASSWORD** appears on the display. Then make a fresh start.*

In case the right password numbers are entered the display will show **FAT COW MILK** - Press the search buttons \blacktriangle , \blacktriangledown to select the milk parameter to be calibrated:

- FAT COW MILK** - cow milk fatness calibration;
- SNF COW MILK** - cow milk Solids non fat (SNF) calibration;
- DEN COW MILK** - cow milk density calibration;
- PROT COW MILK** - cow milk protein calibration;
- FAT SHEEP MILK** - sheep milk fatness calibration;
- SNF SHEEP MILK** - sheep milk Solids non fat (SNF) calibration;
- DEN SHEEP MILK** - sheep milk density calibration;
- PROT SHEEP MILK** - sheep milk protein calibration;
- CONDUCTIVITY** - conductivity calibration (See section "Conductivity calibration")
- PH** - pH calibration (See section "pH calibration")
- TIME & DATE** - time and date calibration (See section "TIME AND DATE CALIBRATION").

Select desired calibration parameter. Confirm it with **OK**.

- The inscription **VALUE** appears on the display.
- Press the buttons \blacktriangle , \blacktriangledown to set the calibration value required.
- The number can range from -2,54 to +2,54 (at interval of 0,02) for fatness, protein and Solids non fat (SNF) and from -12,7 to +12,7 (at interval of 0,10) for density calibration. This number defines the calibration value. When desired value is set on the display press the **OK** button to save it.
- Then the display shows **TOTAL** and a number equal to the total calibration value for this milk parameter. The total calibration value is an algebraic sum of all calibration values added for this milk parameter. The calibration is completed.

Note: The total calibration value can range from -2,54 % to +2,54% (for fatness, protein and Solids non fat (SNF)) and -12,7°C to +12,7°C (for density). In case a bigger number has been

achieved during a calibration procedure a **CAL OUT OF RANGE** error message appears on the display.



CONDUCTIVITY CALIBRATION

For more information see section “**CONDUCTIVITY MEASUREMENT - ADDITIONAL INFORMATION**”)

Conductivity sensor needs to be calibrated on a regular basis (once a month). This assures not only that the sensor is behaving properly but that the system is operating correctly. Ekomilk conductivity calibration is performed at one specific value - 5.02 ($\pm 0,5\%$) mS/cm ($18\pm 0,1^\circ\text{C}$). For conductivity calibration, use only producer's conductivity buffer solution.

Attention: Before conductivity's calibrating, the milk analyzer must be switched on one hour in advance.

Steps:

1. Before calibrating, it is necessary to clean the Ekomilk with water using the procedure described in “**CLEANING OUT - Weekly procedure**”.

2. Fill the measuring mug with conductivity buffer 5.02 ($\pm 0,5\%$) mS/cm ($18\pm 0,1^\circ\text{C}$). Place the measuring mug on the plastic support (5) with the tube (sucker) into the solution. Perform the cleaning procedure once again but use conductivity buffer instead of water. Throw the solution away.

Use the conductivity buffer only once.

3. Press the search buttons \blacktriangle , \blacktriangledown to select **CALIBRATION** mode. Enter the password as it is described in “**CALIBRATION VALUES SAVING**” and select the Conductivity to be calibrated. Confirm it with **OK**. The inscription **LOAD CAL LIQUID** appears on the display.

4. Fill once again the measuring mug with conductivity buffer 5.02 ($\pm 0,5\%$) mS/cm ($18\pm 0,1^\circ\text{C}$).. Place the measuring mug on the plastic support (5) with the tube (sucker) into the solution and press **OK** key. A message **WORKING ...** appears on the display while the calibration measuring is going on.

When the measurement is completed the display shows **CAL FINISHED**. The conductivity calibration procedure is complete. Throw away the used solution.

You may repeat steps 3 and 4 again for better calibration.

Attention: Conductivity buffer solution can be used only once.

5. After calibrating, clean the Ekomilk with water using the procedure described in “**CLEANING OUT - Weekly procedure**”.

COND. CAL ERROR MESSAGE	PROBLEM & CAUSES	REMEDY
CAL ERROR 64	Pump damage	Try again to calibrate the milk analyzer. If the problem still exists, the Pump is out of order. Contact your dealer to make the repairs.
CAL ERROR 65	Wrong buffer solution	Fill the measuring mug with conductivity buffer 5.02 ($\pm 0,5\%$) mS/cm ($18\pm 0,1^\circ\text{C}$) and repeat the calibration procedure.
CAL ERROR 66	Power supply trouble	Switch off the milk analyzer and switch it on after 10-15 sec. Try again to calibrate the milk analyzer. If the problem still exists, the Pump is out of order. Contact your dealer to make the repairs.

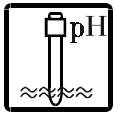

PH CALIBRATION

Attention: To get precise pH results, calibrate the pH measurement system before you measure the pH of the sample or at least twice a week.

For more information see section “**pH MEASUREMENT - ADDITIONAL INFORMATION**”. Calibration is an important part of electrode maintenance. This assures not only that the electrode is behaving properly but that the system is operating correctly. It is recommended that the user perform at least a 2-Point calibration using standard buffers that adequately cover the expected measurement range prior to measurement. 1-Point Calibration can also be used for quick measurements. Ekomilk is capable of 3-point calibration to ensure enhanced accuracy throughout the pH measurement range. The 3 point calibration offers flexibility of calibrating at 3 internationally accepted calibration points namely, pH 7.00, 4.00 and 10.00. pH measurement is temperature sensitive. Automatic Temperature compensation is contained within the milk analyzer. To activate the ATC, simply plug in the temperature probe into the phono jack.

Attention:

It is best to select a buffer as close as possible to the actual pH value of the sample to be measured.

Use standard calibration buffers that the temperature and the sample solution are the same.

Steps:

1. Press the search buttons \blacktriangle , \blacktriangledown to select **CALIBRATION** mode. Enter the password as it is described in “**CALIBRATION VALUES SAVING**” and select the pH to be calibrated. Confirm it with **OK**. The inscription **LOAD PH 7 LIQUID** appears on the display.

This message indicates that pH 7.00 is ready for calibration.

2. Rinse the electrode well with de-ionized water. (Do not wipe the electrode as this may cause a build-up of electrostatic charge on the glass surface!).

3. Fill a measuring mug with the buffer 7.00. Place it on pos. 8 and dip the electrode and temperature probe into the buffer, ensuring that the electrode is completely immersed into the sample. Stir the electrode gently in the buffer.

Once you have selected the correct solution, Press **OK** key to confirm. The message **WAIT, PLEASE....** appears on the display. Wait for the measured pH value to stabilize. The next message **LOAD PH 4 LIQUID** will be displayed when the reading is ready. The Ekomilk is calibrated to buffer 7.00.

NOTE. Press button ▼ to finish calibration. Message **CAL FINISHED** appears. Confirm it with **OK**. The 1-point calibration procedure is now complete.

For 2 or 3 point calibration perform the 1, 2, 3 steps following the Ekomilk prompts until completion.

Attention: pH buffer solutions can be used many times.

CAL ERROR 41	Pump damage	Try again to calibrate the milk analyzer If the problem still exists, the Pump is out of order. Contact your dealer to make the repairs.
CAL ERROR 43	Power supply trouble	Switch off the milk analyzer and switch it on after 10-15 sec. Try again to calibrate the milk analyzer If the problem still exists, the Pump is out of order. Contact your dealer to make the repairs.
CAL ERROR 44	-pH electrode or termosensor is disconnected -pH Electrode damaged -Temperature probe damaged -pH measuring system is damaged	Check the connections. Activate or replace the out of order pH electrode with a new one - see "pH measurement - Additional information" Replace the out of order Temperature probe with a new one. Try again to calibrate the milk analyzer If the problem still exists, the pH measuring system is damaged is out of order. Contact your dealer to make the repairs.
CAL ERROR 46	Wrong buffer solution	Fill the measuring mug with right buffer and repeat the calibration procedure.
CAL ERROR 47	-pH measuring system is damaged	Switch off the milk analyzer and switch it on after 10-15 sec. If the problem still exists, the pH measuring system is out of order. Contact your dealer to make the repairs.



TIME & DATA CALIBRATION

Press the search buttons \blacktriangle , \blacktriangledown to select **CALIBRATION** mode. Enter the password as it is described in "**CALIBRATION VALUES SAVING**" and select **TIME & DATA** to be calibrated. Press **OK** to confirm.

The message **TIME: 00:00:00** appears on the display:

- button \blacktriangledown changes the cursor position;
- button \blacktriangle changes the over cursor value;
- button **MODE** cancels the changes and returns **COW MILK** on the display;
- button **OK** confirms the **TIME** and shows **DATA: 00:00:00**;
- button \blacktriangledown changes the cursor position;
- button \blacktriangle changes the over cursor value;
- button **MODE** cancels the changes and returns **COW MILK** on the display;
- button **OK** confirms the **DATE** and shows **TIME SET OK**.

If **TIME & DATA** Chip is not installed or does not work properly or a incorrect Time or Date value has been achieved during a calibration procedure a error message **ERROR SETTING TIME** appears on the display.

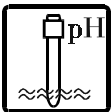

PH MEASUREMENT - ADDITIONAL INFORMATION

1. General

pH is a unit to measure which describes the degree of acidity or alkalinity of a solution. It is measured on scale of 0 to 14. The term pH is derived from “p”, the mathematical symbol of the negative logarithm, and “H”, the chemical symbol of Hydrogen. The formal definition of pH is the negative logarithm of the Hydrogen ion activity.

2. pH Electrode

For pH measurement Ekomilk needs a combination electrode, compatible with most pH electrodes that have BNC connectors and zero potential (the pH where the millivolt output of the electrode equals 0) near 7 pH.

2.1. Electrode part

The electrode is the most important part of the pH measurement. The electrode glass membrane is fragile and must be handled with care. To protect the glass membrane and to maintain activation, the glass membrane is covered by a protective rubber cap containing a suitable storage solution.

2.2. Electrode care & Electrode maintenance

pH Electrodes are susceptible to dirt and contamination and need to be clean regularly depending on the extent and condition of use. At no time should one touch or rub the glass bulb as this causes the build-up of electrostatic charge.

2.3. Storage

The best results, always keep the pH bulb wet. An optimal storage solution for combination electrode is pH 4 buffer (clear not pink) with 225 grams of KCl per liter. Table salt, NaCl, can be used if KCl is not really available. Other pH buffers or tap water are also acceptable storage media, but avoid storage in de-ionized water. The protective rubber cap filled with the buffer solution provides ideal storage for long periods.

2.4. After Use

After measurement is complete, follow the sequence elaborated below for storage.

a) Wash the electrode and reference junction in de-ionized water.



b) Close the refilling hole by returning its rubber sleeve or stopper cap (Necessary for only refillable electrode).

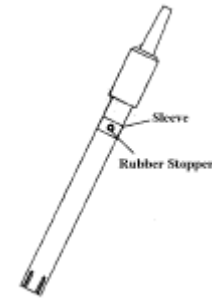

c) Store the electrode as mentioned above (see section Storage).

2.5. Electrolyte Replacement (for refillable electrode only).

The reference electrolyte needs to be refilled when the electrode has been used for an external period, or when the internal electrolyte has dried up. To accomplish this, follow the procedure detailed below.

a) Remove the protective rubber cap or sleeve.

Remove the protective rubber sleeve to expose the filling port of the electrode. Remove the old reference electrolyte with a syringe.

b) Fill the new reference electrolyte.

New electrolyte preparation:

Open the small container with KCl.

Add in de-ionized water until it reaches the level of 20 ml. Close the container and shake it to dissolve the KCl.

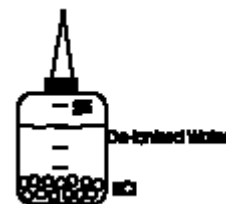

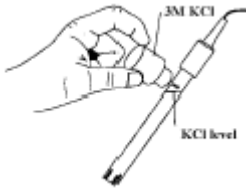

Add in fresh electrolyte until it reaches the level of the refilling port. The reference electrolyte used should be 3M (Mol) KCl. Replace the rubber sleeve.

c) Re-use the electrode

Rinse the liquid junction with de-ionized water.

Note: If these steps fail to restore normal electrode response, you may attempt to rejuvenate it. (See: Electrode Rejuvenation).

2.6. Electrode cleaning

Electrodes which are mechanically intact can often be restored to normal performance by one or combination of the following procedures.

a) Salt deposits:

Dissolve the deposit by immersing the electrode in tap water for ten to fifteen minutes. Then thoroughly rinse with de-ionized water.



b) Oil/Grease Films

Wash electrode pH bulb in a little detergent and water. Rinse electrode tip with de-ionized water.



c) Clogged Reference Junction: pH electrodes have junction which allows the internal fill solution of the measuring electrode to leak out into the solution being measured. The junction can become clogged by particulate in the solution. If a clogged junction is suspected it is best to clear the junction.

Heat a dilute KCl solution to 60-80°C. Place the sensing portion of the pH electrode into the heated KCl solution for approximately 10 minutes.

Allow the electrode to cool while immersed in some unheated KCl solution.

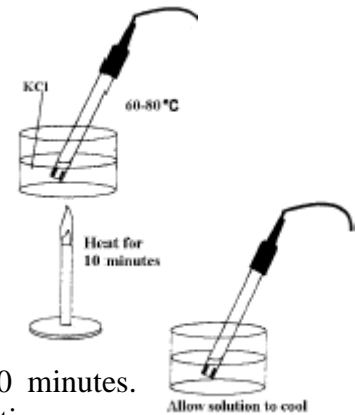

d) Protein Deposits

Prepare a 1% pepsin solution in 0.1M HCl. Allow the electrode to stand in this solution for five to ten minutes. Rinse the electrode with de-ionized water.

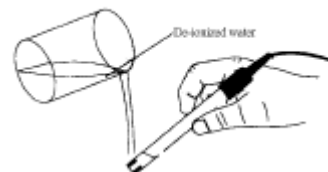
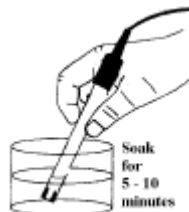
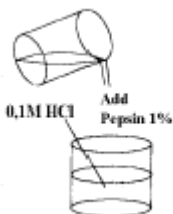

2.7. Electrode activation

Generally, if the procedure of storage and maintenance had been closely followed, the electrode can be used immediately. However, should the electrode response become sluggish, it may be possible

that the bulb has dehydrated. The bulb can be rehydrated by immersing the electrode in an ideal storage solution (e.g. buffer pH 4 solution) for 1 - 2 hours. If this fails, the electrode may require re-activation.

If the above procedure does not reactivate the electrode to acceptable status, try rejuvenation the electrode by following the procedure outlined below.

2.8. Rejuvenation Procedure

a) Dip and stir the electrode in freon or alcohol for 5 minutes.

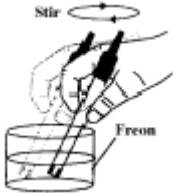

b) Leave the electrode in tap water for 15 minutes.

c) Dip and stir the electrode in concentrated acid (HCl , H_2SO_4) for 5 minutes.

d) Repeat Step b - leave the electrode in tap water for 15 minutes.

e) Dip and stir in strong base (NaOH) for 5 minutes.

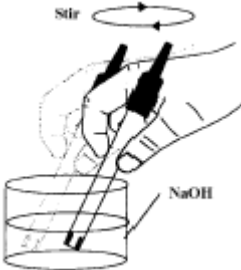

f) Repeat Step b - leave the electrode in tap water for 15 minutes.

g) Test with standard calibration solution.

Finally, test with standard calibration buffer solution to see if the electrode yields acceptable results. You may repeat steps 'c' to 'f' again for better response (maximum 3 times). If the response does not improve, then the electrode has completed its useful life. Replace with a new electrode.

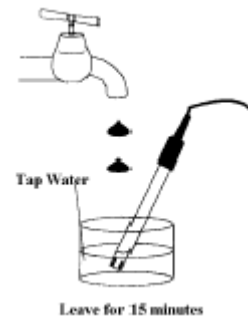

3. Electrode Lifespan

pH electrodes have a finite lifespan due to their inherent properties. How long a pH electrode will last will depend on how it is cared and the solution it is used to measure. Even if an electrode is not used it still ages. Electrode demise can usually be characterized by a sluggish response, erratic readings or a reading which will not change. When this occurs an electrode can no longer be calibrated. pH electrodes are fragile and have a limited lifespan. How long an electrode will last is determined by how well the is maintained and the pH application. The harsher the system, the shorter the lifespan. For this reason it is always a good idea to have a back-up electrode on hand to avoid any system down time.

4. Buffer Solutions

Buffers are solutions that have constant pH values and the ability to resist changes in that pH level. They are used to calibrate pH measurement system.

5. Automatic Temperature Compensation (ATC)

Automatic Temperature compensation is contained within the milk analyzer, because pH measurement is temperature sensitive. To activate the ATC, simply plug in the temperature probe into the phono jack.

6. pH Electrode Calibration

pH Electrodes are like batteries; they run down with time and use. As an electrode ages, its glass changes resistance. For this reason, electrodes need to be calibrated on a regular basis. Calibration in pH buffer solution corrects for this change.

Calibration is an important part of electrode maintenance. This assures not only that the electrode is behaving properly but that the system is operating correctly.

Usually pH meters require calibration at 3 specific pH values. One calibration is usually performed at pH 7, second and third are typically performed at pH 4 and pH 10.

Attention: It is best to select a buffer as close as possible to the actual pH value of the sample to be measured. Use standard calibration buffers that the temperature and the sample solution are the same.

7. Milk acidity and pH

The following table shows the relation between pH value and °T.

°T	Variations	pH (average value)	°T	Variations	pH (average value)
Raw milk			Pasteurize milk		
16	6,74 - 6,70	6,72	16	6,68 - 6,64	6,66
17	6,69 - 6,65	6,68	17	6,63 - 6,58	6,61
18	6,64 - 6,58	6,62	18	6,57 - 6,52	6,55
19	6,57 - 6,52	6,55	19	6,51 - 6,46	6,49
20	6,51 - 6,46	6,49	20	6,45 - 6,40	6,43
21	6,45 - 6,40	6,43	21	6,39 - 6,35	6,37
22	6,39 - 6,35	6,37	22	6,34 - 6,30	6,32
23	6,34 - 6,30	6,32	23	6,29 - 6,24	6,26
24	6,29 - 6,24	6,25	24	6,23 - 6,19	6,21



MILK CONDUCTIVITY - ADDITIONAL INFORMATION:

Conductivity (or Electrolytic Conductivity) is defined as the ability of a substance to conduct electrical current. It is the reciprocal of the resistivity.

In a healthy animal*, the mean value of electric conductivity is:

- cow milk - between 4 to 6 mS/cm (18°C);
- sheep milk - between 3 to 5 mS/cm (18°C);
- buffalo - between 2,5 to 5 mS/cm (18°C);

*These values depend on the geographical region, the race and on other factors.

Milk conductivity changes on the concentration of ions in the milk:

- Added salts increase the ion's concentration. Milk conductivity increases.
- Added water, sugar, proteins, insoluble solids decrease the ion's concentration. Milk conductivity decreases.
- Significantly extreme value (6,5 - 13,00 mS/cm (18°C)) should indicate the development of mastitis. Infections damage the tissue of the udder. This allows sodium and chlorine ions from the blood to be released into the milk. The concentration of ions in the milk is thereby raised, and it can more easily conduct an electrical current - the conductivity of the milk increases.
- Milk conductivity can be used as a test of grade of water evaporation in production of condense milk.
- Milk conductivity change notifies of powder (dry) milk solution rate.



ERROR'S LIST

ERROR MESSAGE	TYPE	PROBLEM & CAUSES	REMEDY
1. MOTOR ERROR	Motor	MOTOR DAMAGE	Replace the out of order Pump with a new one (see Assemblies Replacing Procedures).
2. EMPTY CAMERA	Measuring system	Air bubble in the measuring sensor. The suction system has some air leak.	Fill again the mug with the same milk sample and make a fresh start. 1. Check the Rubber Plug position and fix if necessary. If the Rubber Plug stays loose in the Syringe, replace the Syringe. 2. Test the analyzer in Motor off mode. If no problem occurs in this mode, the

ERROR MESSAGE	TYPE	PROBLEM & CAUSES	REMEDY
		Measuring system contaminated or damaged	<p>Pump is out of order. Replace the out of order Pump with a new one and put the Analyzer in MOTOR ON mode (see Assemblies Replacing Procedures).</p> <p>If the problem still exists see next cause.</p> <p>Replace the out of order Measuring System with a new one (see Assemblies Replacing Procedures).</p>
3. HOT SAMPLE	Measuring system	<p>Milk sample's temperature above the spec.</p> <p>Measuring system contaminated or damaged</p>	<p>Fill again the mug with proper temperature milk sample and make a fresh start.</p> <p>Replace the out of order Measuring System with a new one (see Assemblies Replacing Procedures).</p>
4. WRONG PASSWORD	Calibration	Incorrect Password	Re-enter the password
5. CAL OUT OF RANGE	Calibration	Attempt to enter a calibration value out of allowed limits.	<p>The total calibration value can range from -2,54 % to +2,54% (for fatness, protein and Solids non fat (SNF)) and -12,7^oA to +12,7^oA (for density). In case a bigger number has been achieved during a calibration procedure a CAL OUT OF RANGE error message appears on the display.</p> <p>If a calibration value out of allowed limits is really needed, Measuring system is out of order and must be replaced (see Assemblies Replacing Procedures).</p>
6. ERROR 03	Wrong PROM check sum	PROM is damaged or erased.	Reprogram PROM with correct value
7. ERROR 06	Measuring system Data collection	Incorrect or lost data. (Stored data for suppliers and milk parameters was lost)	<p>To correct this error you must refresh Analyzer's memory. Press MODE button, select with search buttons ▲, ▼ SEND & CLEAR, confirm with OK. The message PLEASE, WAIT... appears on the display while memory clearing is going on. Wait for message TRANSFER OK? Y and press OK to confirm the clearing procedure. Message READY confirms that memory refresh process is completed.</p>
8. ERROR 07	There is no communication between the main processor and PROM	PROM is burnt or not properly put in the socket	Change PROM.
9. ERROR 09	Measuring system	<p>The power supply voltage is below spec.</p> <p>Measuring system out of order</p>	<p>Use proper power supply voltage value.</p> <p>Replace the out of order Measuring System with a new one (see Assemblies Replacing Procedures).</p>

ERROR MESSAGE	TYPE	PROBLEM & CAUSES	REMEDY
10. ERROR 10	Measuring system	See EMPTY CAMERA	See EMPTY CAMERA
11. ERROR 11	Measuring system	See EMPTY CAMERA	See EMPTY CAMERA
12. ERROR SETTING TIME	TIME & DATA	TIME & DATA Chip is not installed or does not work properly. Incorrect Time or Date value.	Check the TIME & DATA Chip Enter right value
13. CAL ERROR 41	pH calibration	Pump damage	Try again to calibrate the milk analyzer If the problem still exists, the Pump is out of order. Contact your dealer to make the repairs.
14. CAL ERROR 43	pH calibration	Power supply trouble	Switch off the milk analyzer and switch it on after 10-15 sec. Try again to calibrate the milk analyzer If the problem still exists, the Pump is out of order. Contact your dealer to make the repairs.
15. CAL ERROR 44	pH calibration	-pH electrode or termosensor is disconnected -pH Electrode damaged -Temperature probe damaged -pH measuring system is damaged	Check the connections. Activate or replace the out of order pH electrode with a new one - see "pH measurement - Additional information" Replace the out of order Temperature probe with a new one. Try again to calibrate the milk analyzer If the problem still exists, the pH measuring system is damaged is out of order. Contact your dealer to make the repairs.
16. CAL ERROR 46	pH calibration	Wrong buffer solution	Fill the measuring mug with right buffer and repeat the calibration procedure.
17. CAL ERROR 47	pH calibration	-pH measuring system is damaged	Switch off the milk analyzer and switch it on after 10-15 sec. If the problem still exists, the pH measuring system is out of order. Contact your dealer to make the repairs.
18. CAL ERROR 64	Conductivity calibration	Pump damage	Try again to calibrate the milk analyzer If the problem still exists, the Pump is out of order. Contact your dealer to make the repairs.
19. CAL ERROR 65	Conductivity calibration	Wrong buffer solution	Fill the measuring mug with conductivity buffer 5.02 ($\pm 0,5\%$) mS/cm ($18\pm 0,1^\circ\text{C}$) and repeat the calibration procedure.
20. CAL ERROR 66	Conductivity calibration	Power supply trouble	Switch off the milk analyzer and switch it on after 10-15 sec. Try again to calibrate the milk analyzer If the problem still exists, the Pump is out of order. Contact your dealer to make the repairs.

ERROR MESSAGE	TYPE	PROBLEM & CAUSES	REMEDY
21. NO MEMORY SPACE	Data collection	Attempt to enter a new record out of allowed number.	The maximum number of records can be 120. If you try to write more records, NO MEMORY SPACE error message appears on the display. In this case you must transfer the data to a computer and clear (empty) the Analyzer's memory (See procedure described in section "Data transferring" - User's Guide).

GUARANTEE

Guarantee is one full year. Guarantee is void if warranty labels are removed. Under no circumstance you should try to repair the Analyzer yourself, as this will invalidate the guarantee. The guarantee conditions for this analyzer are as defined by our representative in the country of sale.

Password:

Serial N:

Date:
